



2003 - 2011

FIAT PANDA 2WD

Cat. No. **F/022**

e20

e20*94/20*0715*00

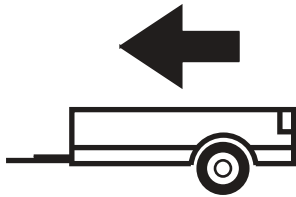

900kg



60kg

D = 6,33kg

D (kN) =



MAX kg

x

MAX kg

x 0,00981



MAX kg

+

MAX kg

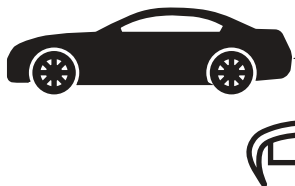

IMIOLA HAK-POL

96-111 KOWIESY, CHOJNATA 23A, POLAND

Tel. + 48 46 831 73 31, fax +48 831 74 29

e-mail: office@imiola.pl, www.imiola.pl



PRZEKRÓJ A-A

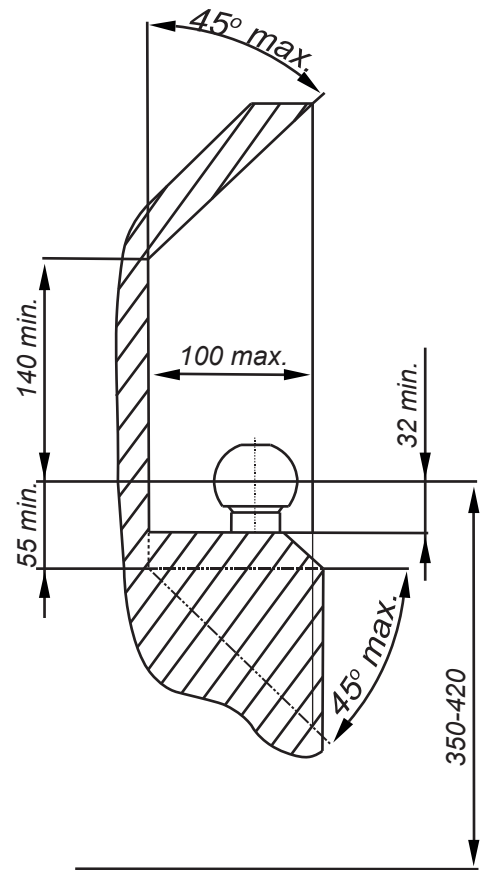

PL Należy zagwarantować przestrzeń swobodną według załącznika VII, rysunek 25a/b Regulaminu EKG ONZ 55.01 przy dopuszczalnym ciężarze całkowitym pojazdu.

F L'espace libre doit être garanti conformément à l'annexe VII, illustration de la réglementation 55.01 CE pour un poids total en charge autorisé du véhicule.







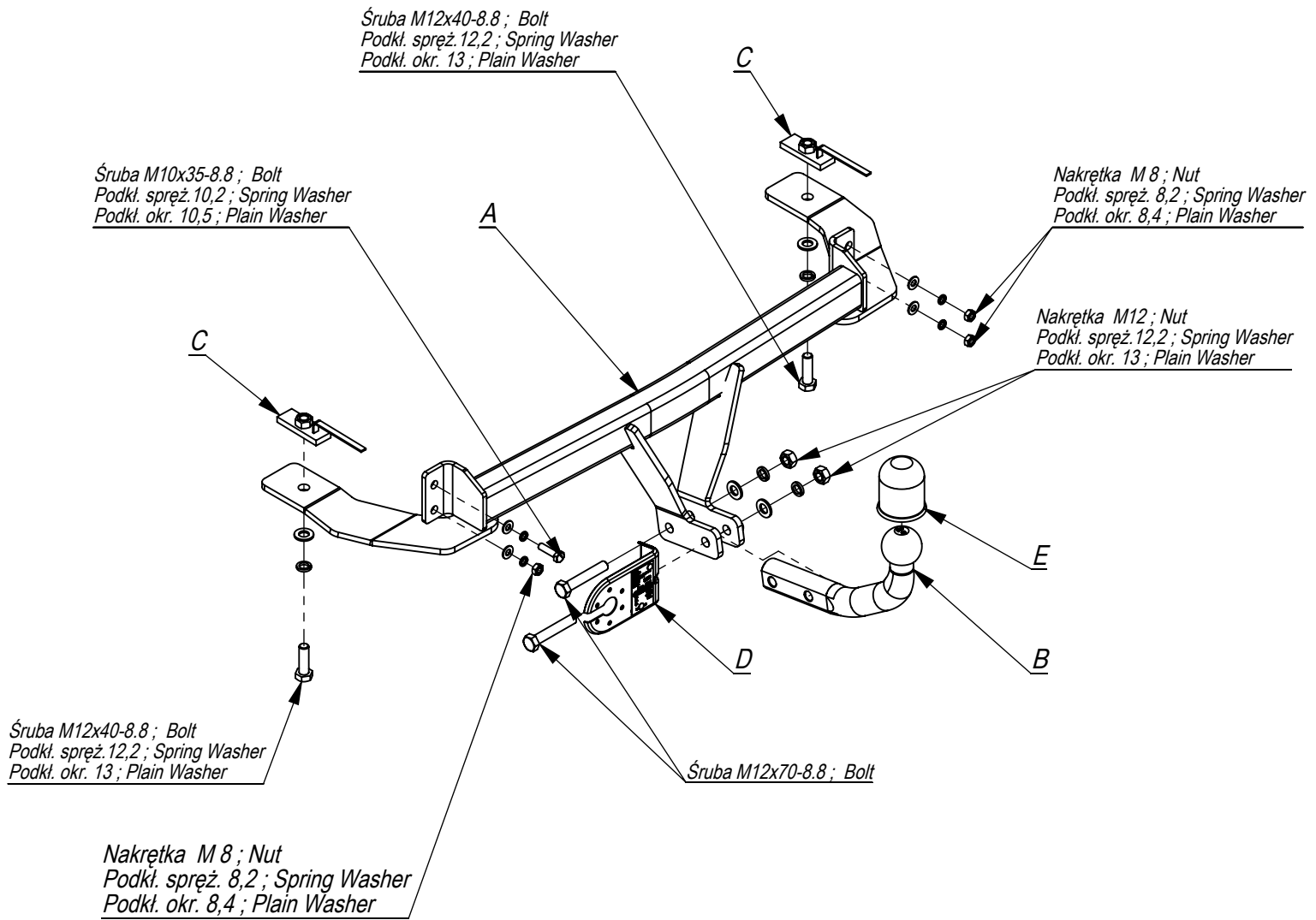

GB The clearance specified in appendix VII, diagram 25a/b of Regulation No. 55.01 UN EU must be guaranteed at laden weight of the vehicle.

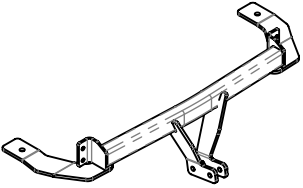
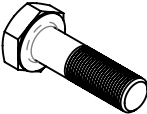
D Der Freiraum nach Anhang VII, Abbildung 25a/b der Vorschriften 55.01 EG ist zu gew 25a/bahrleisten bei zulässigem Gesamtgewicht des Fahrzeuges.

Moment skręcący dla śrub i nakrętek (8.8) Torque settings for nuts and bolts (8.8)	
M8	25Nm
M10	55Nm
M12	85Nm
M14	135Nm
M16	195Nm





	A	x1		M12x70	2
				M12x40	2
				M10x35	1
	B	x1		M12	2
				M8	3
	C	x2		13	4
				10,5	1
				8,5	3
	D	x1		12,2	4
				10,2	1
				8,2	3
	E	x1			

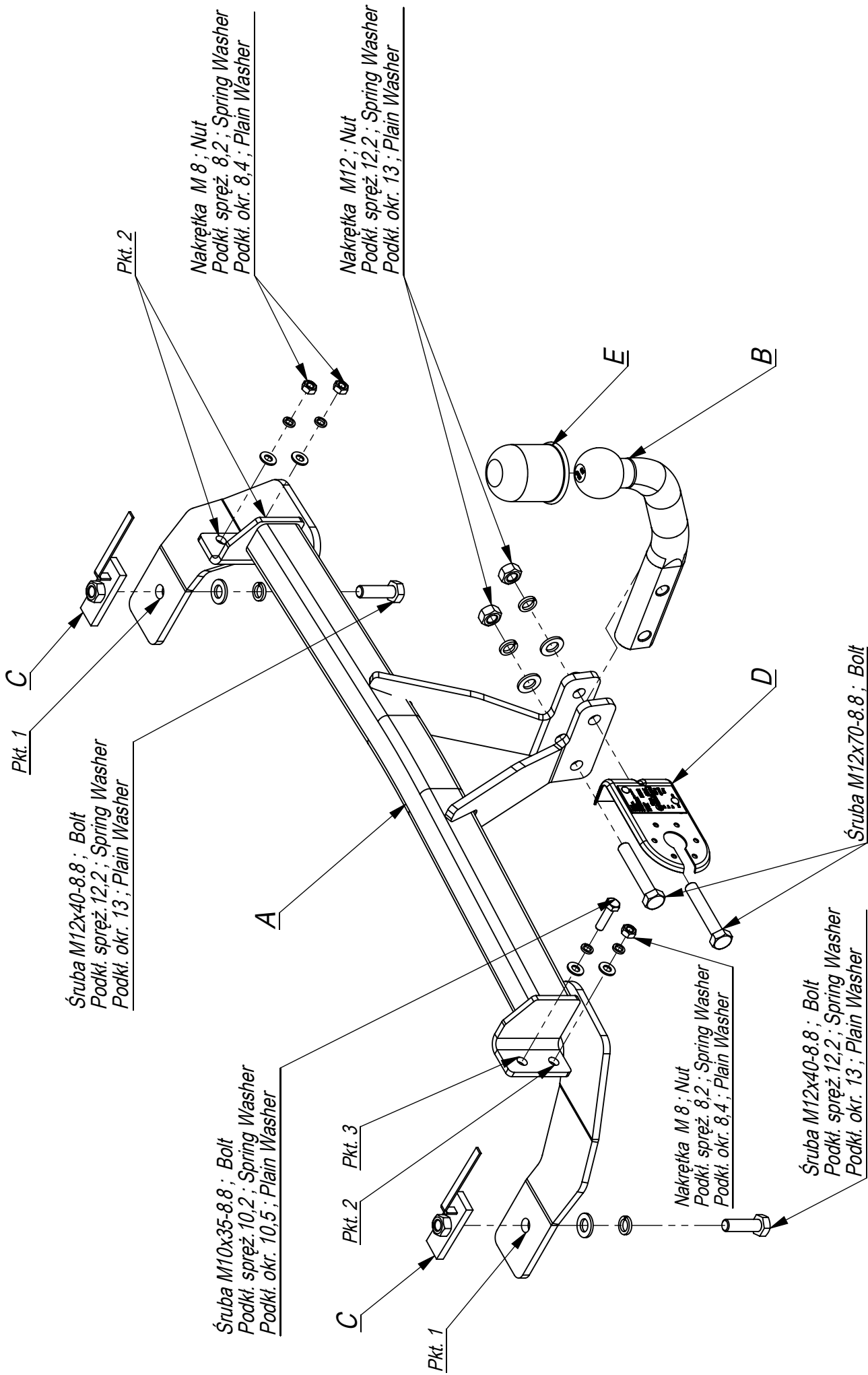

- Odkręcić zderzak.
- Opuścić tłumik z tylnego zawieszenia.
- Odnitować blachę termiczną.
- Odkręcić metalowe wzmocnienie nie będzie wykorzystane.
- Przykręcić do tylnego pasa belkę haka A nakrętkami M8 (pkt2) oraz śrubą M10x35 8.8 (pkt 3)
- Poprzez technologiczne otwory w podłużnicach włożyć wkładki C i przykręcić śrubami M12x40 8.8 (pkt 1).
- Dokręcić wszystkie śruby z momentem wg tabeli.
- Zamontować blachę termiczną.
- Zawiesić tłumik.
- Zamontować zderzak.
- Przykręcić kulę i blachę gniazda elektrycznego.
- Podłączyć instalację elektryczną.

- Unscrew the bumper.
- Lower the muffler from the rear hanger.
- Unrivet the thermal shield.
- Unscrew the metal reinforcement of the bumper. It will not be used any more.
- Screw slightly the main bar A to the rear belt with nuts M8 (point 2) and bolt M10x35 8.8 (point 3).
- Insert the plates C through the technological holes in the frame side members and screw with bolts M12x40 8.8 (point 1).
- Tighten all the bolts according to the torque setting-see the table.
- Assemble the thermal shield.
- Assemble the muffler.
- Screw the bumper.
- Fix the ball and electric plate.
- Connect the electric wires.

- Serrer le pare-chocs.
- Descendre le silencieux de la suspension arrière.
- Deriveter la tôle thermique.
- Desserrer le renfort en acier de pare-chocs.
- Serrer légèrement la traverse de corchet A à la partie arrière avec les écrous M10 et les boulons M8x30 8.8.
- Insérer les plaquettes C à travers les ouvertures de longerons et serrer les avec les flancs de crochet par les boulons M12x40 8.8.
- Serrer tous les boulons avec un couple de serrage selon tableau.
- Poser la tôle thermique.
- Accrocher le silencieux.
- Poser le pare-chocs,
- Visser la boule et tôle de la prise électrique.
- Raccorder le circuit électrique.

- Die Stoßstange abschrauben.
- Den Auspufftopf aus der hinteren Aufhängung entfernen.
- Das Vernieten des Thermoschutzblechs entfernen.
- Die Metallverstärkung der Stoßstange abschrauben.
- An den hinteren Karosseriestreifen den Querbalken A M8-Muttern und mit den Schrauben M10x35 8.8 locker anschrauben.
- Durch die vom Werk aus in den Längsträgern vorhandenen Öffnungen, die Einlagen C einlegen und mit der Anhängerkupplungsseite mit den Schrauben M12x40 8.8 verschrauben.
- Alle Schrauben mit dem in der Tabelle angegebenen Drehmoment festziehen.
- Die Thermoschutzblech einbauen.
- Den Auspufftopf einbauen.
- Die Stoßstange einbauen.
- Die Kugel und die Steckdosenhalterung anschrauben. Die Elektroinstallation anschließen.

- Desenrosque el parachoques y el refuerzo metálico del parachoques (ya no se usarán)
- Baje el silenciador de la suspensión.
- Desmontar el escudo térmico
- Fijar la barra del gancho a la correa trasera con tornillos M10x35 (punto 3) y tuercas M8 (punto 2).
- Insertar las barras planas con las tuercas C en los largueros y fijelos con pernos M12x40 8.8 (punto 1).
- Apretar todos los tornillos con el par según la tabla anterior.
- Instalar el escudo térmico
- Fijar el silenciador.
- Fijar el parachoques.
- Atornille la bola y la placa de toma de corriente eléctrica. con tornillos M12x70 8.8.
- Conectar la instalación eléctrica.

