



2015 -

RENAULT KADJAR (excl. Adblue)

Cat. No. **R/059**

E20

E20 55R-01 4813

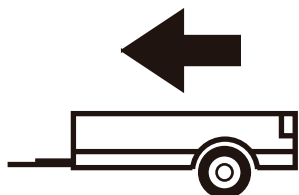

2000kg



75kg

D=12,81kN

D (kN) =



MAX kg

x

MAX kg

x 0,00981



MAX kg

+

MAX kg



IMIOLA HAK-POL

96-111 KOWIESY, CHOJNATA 23A, POLAND

Tel. + 48 46 831 73 31, fax +48 831 74 29

e-mail: office@imiola.pl, www.imiola.pl

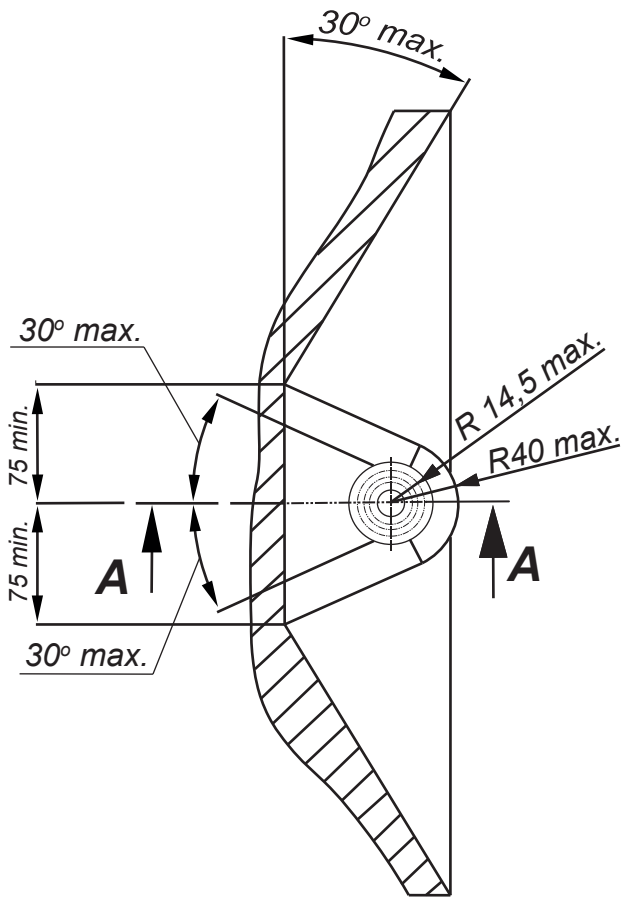

PRZEKRÓJ A-A

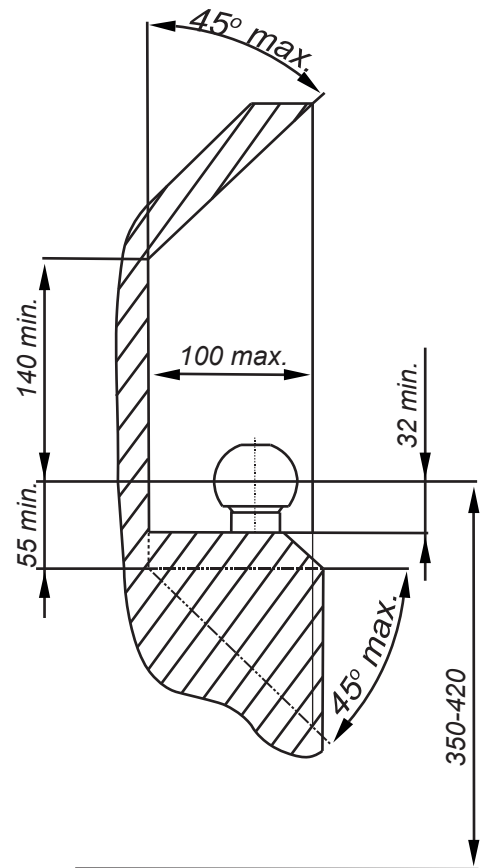

PL Należy zagwarantować przestrzeń swobodną według załącznika VII, rysunek 25a/b Regulaminu EKG ONZ 55.01 przy dopuszczalnym ciężarze całkowitym pojazdu.

F L'espace libre doit être garanti conformément à l'annexe VII, illustration de la réglementation 55.01 CE pour un poids total en charge autorisé du véhicule.

GB The clearance specified in appendix VII, diagram 25a/b of Regulation No. 55.01 UN EU must be guaranteed at laden weight of the vehicle.

D Der Freiraum nach Anhang VII, Abbildung 25a/b der Vorschriften 55.01 EG ist zu gew 25a/bahrleisten bei zulässigem Gesamtgewicht des Fahrzeuges.

Moment skręcający dla śrub i nakrętek (8.8) Torque settings for nuts and bolts (8.8)	
M8	25Nm
M10	55Nm
M12	85Nm
M14	135Nm
M16	195Nm



Śruba M10x35-8.8 ; Bolt
 Podkł. spręż. 10,2 ; Spring Washer
 Podkł. okr. Ø30xØ10,5x 3 ; Plain Washer

Nakrętka M10 ; Nut
 Podkł. spręż. 10,2 ; Spring Washer
 Podkł. okr. 10,5 ; Plain Washer

Nakrętka M12 ; Nut
 Podkł. spręż. 12,2 ; Spring Washer
 Podkł. okr. 13 ; Plain Washer

Śruba M12x40-8.8 ; Bolt

Śruba M10x35-8.8 ; Bolt
 Podkł. okr. Ø30xØ10,5x 3 ; Plain Washer

Śruba M10x35-8.8 ; Bolt
 Podkł. okr. Ø30xØ10,5x 3 ; Plain Washer

Śruba M12x40-8.8 ; Bolt

Śruba M12x40-8.8 ; Bolt

Śruba M10x35-8.8 ; Bolt
 Podkł. spręż. 10,2 ; Spring Washer
 Podkł. okr. Ø30xØ10,5x 3 ;
 Plain Washer

Śruba M12x40-8.8 ; Bolt
 Podkł. spręż. 12,2 ; Spring Washer
 Podkł. okr. 13 ; Plain Washer











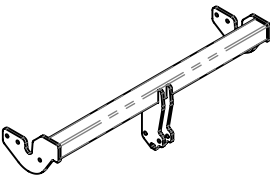
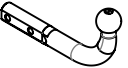

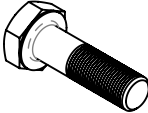

Nakrętka M10 ; Nut
 Podkł. spręż. 10,2 ; Spring Washer
 Podkł. okr. 10,5 ; Plain Washer

Śruba M12x70-8.8 ; Bolt

Śruba M12x40-8.8 ; Bolt

Nakrętka M12 ; Nut
 Podkł. spręż. 12,2 ; Spring Washer
 Podkł. okr. 13 ; Plain Washer

Śruba M12x40-8.8 ; Bolt
 Podkł. spręż. 12,2 ; Spring Washer
 Podkł. okr. 13 ; Plain Washer

	A	x1									M12x70	2
											M12	10
											M10	2
											Ø30xØ10,5x3	4
											13	12
											10,5	2
											12,2	12
											10,2	4

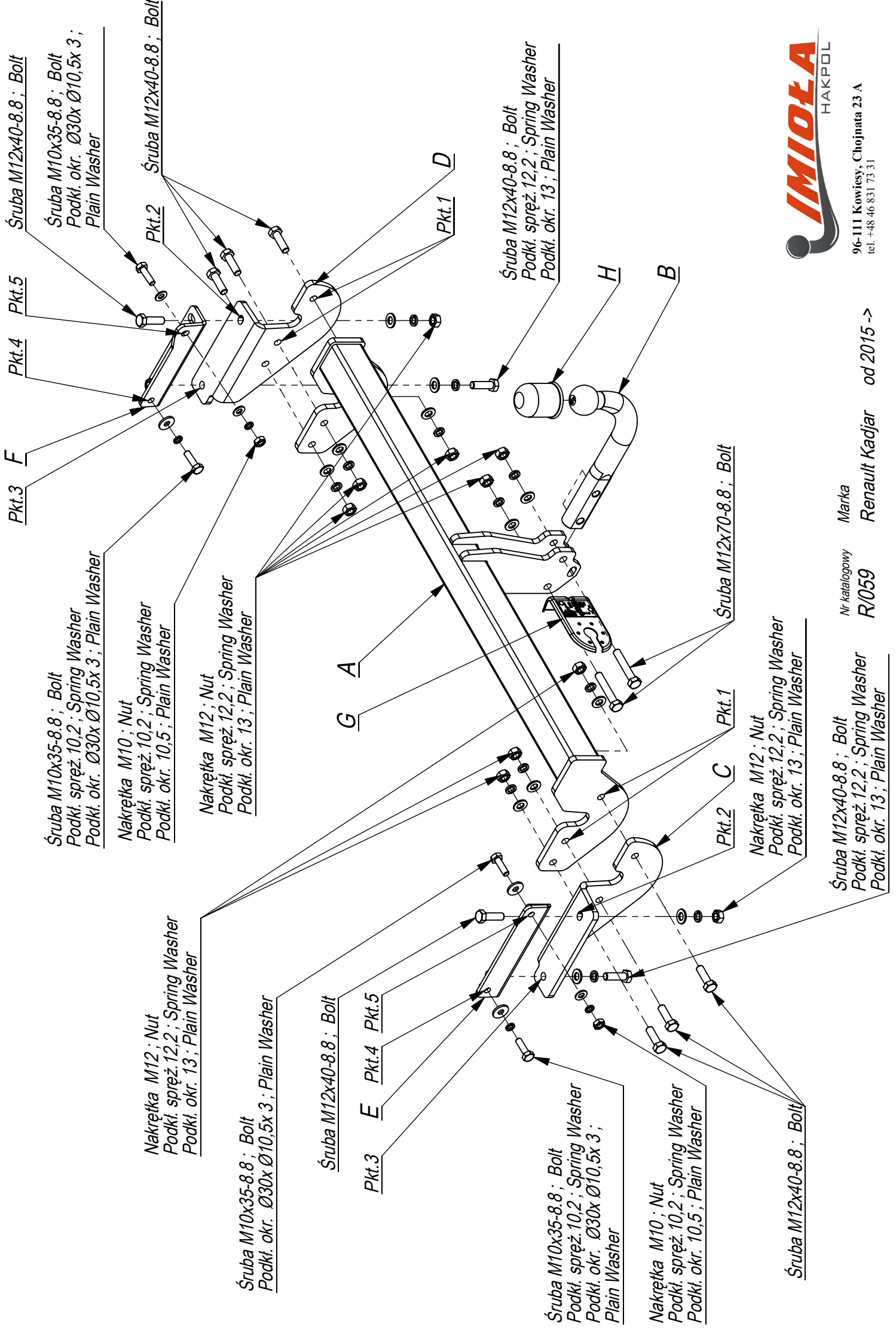

96-111 Kowiesy, Chojnata 23 A
tel. +48 46 831 73 31

Nr katalogowy R/059
Marka Renault Kadjar od 2015 ->

Śruba M12x40-8.8 ; Bolt
Podkl. spręż. 12,2 ; Spring Washer
Podkl. okr. 13 ; Plain Washer

- Odkręcić zderzak, lampy i belkę zderzeniową (nie będzie wykorzystana).
- Udrożnić technologiczne otwory i wsunąć do podłużnic elementy E i F.
- Przykręcić elementy C i D do podłużnic śrubami M12x40 (pkt 2, 3) oraz śrubami M10x 35 (4 i 5)
- Do elementów C i D przykręcić belkę zaczepu A śrubami M12x40 8.8 (pkt 1).
- Dokręcić wszystkie śruby z momentem wg tabeli.
- Założyć zderzak i lampy.
- Przykręcić kulę i blachę gniazda elektrycznego.
- Podłączyć instalację elektryczną.

- Unscrew the bumper, lamps and bumper bar (it will not be used any more).
- Clear the technological holes and insert the elements E and F in the frame side members.
- Screw the elements C and D to the frame side members with bolts M12s40 (point 2 and 3) and with bolts M10x35 8.8 (point 4 and 5).
- Screw the main bar A to the elements C and D with bolts M12x40 8.8 (point 1).
- Tighten all the bolts according to the torque setting- see the table.
- Assemble the bumper and lamps.
- Fix the ball and electric plate.
- Connect the electric wires.

- Dévisser le pare-chocs, les lampes et la barre pare-chocs (non utilisée ultérieurement).
- Déboucher les trous technologiques et glisser les éléments E et F dans les longerons.
- Serrer les éléments C et D aux longerons à l'aide de boulons M12x40 (pts 2, 3) et de boulons M10x 35 (4 et 5)
- Serrer la barre d'attelage A aux éléments C et D à l'aide de boulons M12x40 8.8 (pt 1).
- Serrer tous les boulons avec un couple de serrage selon tableau.
- Installer le pare-chocs et les lampes.
- Visser le crochet d'attelage et socle de prise électrique.
- Raccorder le circuit électrique.

- Die Rückleuchten, die Stoßstange und Verstärkung abschrauben.
- Die Gewindebohrungen in den Längsträgern säubern.
- Die AHK-Bauteile E und F mit Schrauben M10x35 8.8 (Punkt 4,5) an die Längsträger und mit Schrauben M12x40 8.8 an die Bauteile C und D (Punkt 2) anschrauben.
- Den AHK-Querträger A an die Bauteile C und D mit Schrauben M12x40 8.8 anschrauben (Punkt 1).
- Ziehen Sie alle Schrauben mit dem Drehmoment gemäß der Tabelle an.
- Die elektrische Installation anschließen.
- Die AHK-Kugel und die Steckdosenplatte festziehen

- Desenrosque el parachoques y la barra de impacto (ya no es necesario).
- Limpiar los oricios tecnológicos y insertar los elementos E y F a la largueros.
- Apretar los elementos C y D a la largueros con tornillos M10x35 8.8 (puntos 4, 5).
- Atornillar la viga de la bola de remolque A a los elementos C y D usando tornillos M12x40 8.8 (punto 1).
- Apretar todos los tornillos con el par según la tabla anterior.
- Montar el parachoques y las luces.
- Apretar la bola y la placa de la toma eléctrica.
- Conectar la instalación eléctrica.

