



SUBARU

Tribeca

09/2006 -

Cat. No. U/A03

E20

E20 55R-01 5068

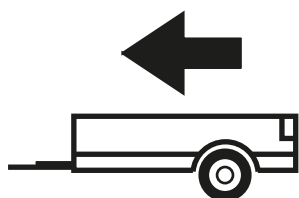

2 000kg

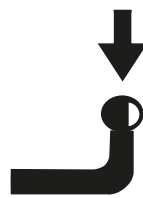

80kg

D = 11,10kN

D (kN) =



MAX kg

x

MAX kg

x 0,00981



MAX kg

+

MAX kg

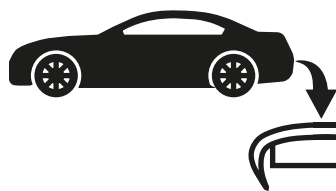

IMIOLA HAK-POL

96-111 KOWIESY, CHOJNATA 23A, POLAND

tel. +48 46 831 73 31, fax +48 831 74 29

e-mail: office@imiola.pl, www.imiola.pl

Rys. 25a

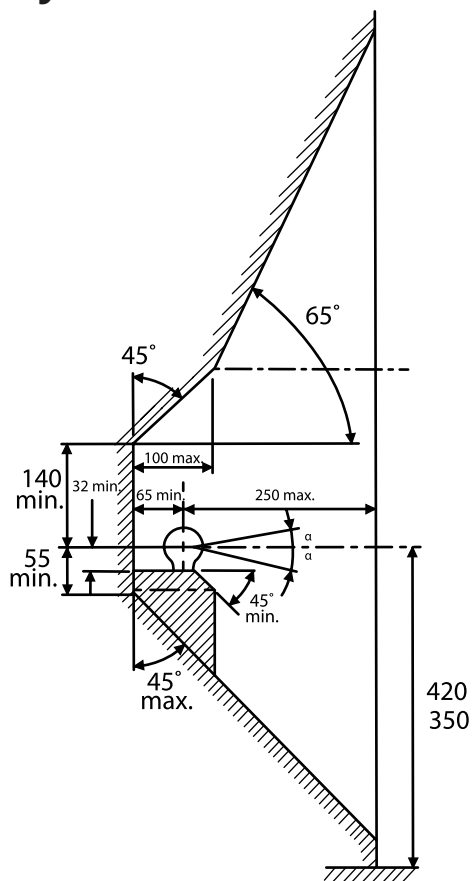

Rys. 25b

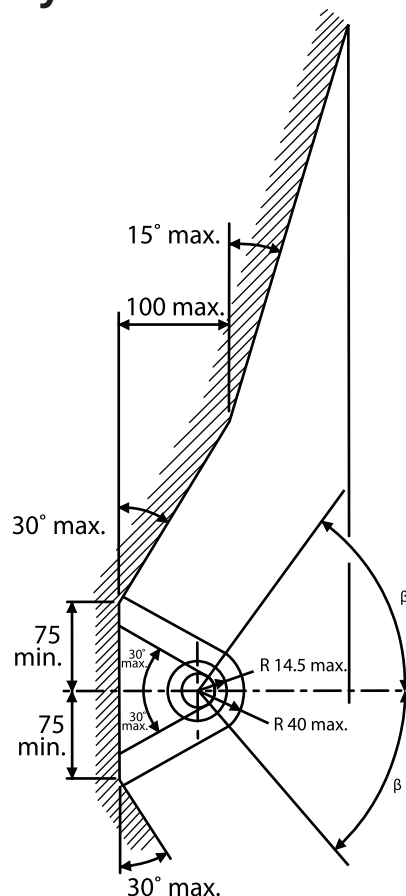

PL Należy zagwarantować przestrzeń swobodną według załącznika VII, rysunek 25a/b Regulaminu EKG ONZ 55.01 przy dopuszczalnym ciężarze całkowitym pojazdu.

GB The clearance specified in appendix VII, diagram 25a/b of Regulation No. 55.01 UN EU must be guaranteed at laden weight of the vehicle.







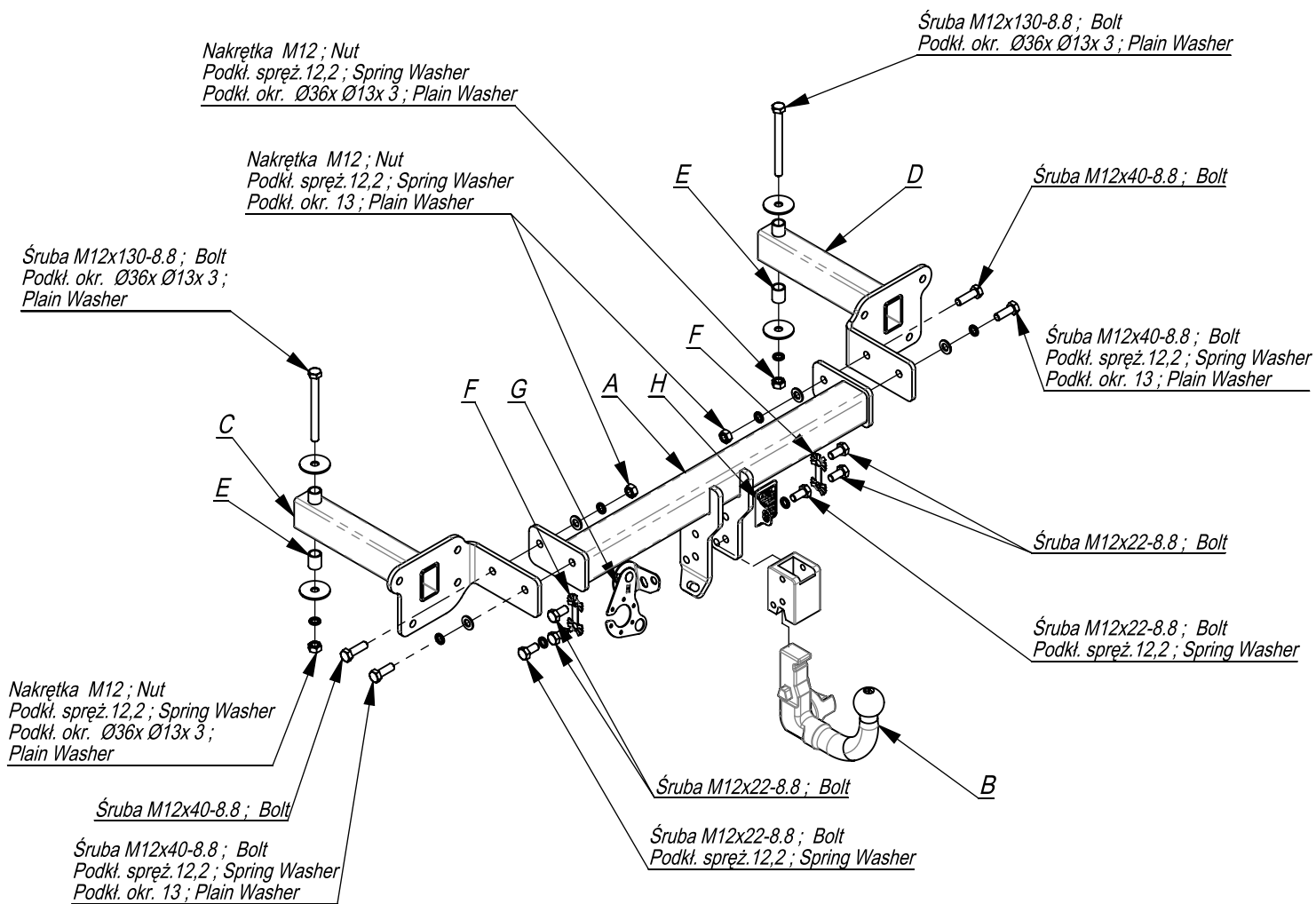

FR L'espace libre doit être garanti conformément à l'annexe VII, illustration de la réglementation 55.01 CE pour un poids total en charge autorisé du véhicule.

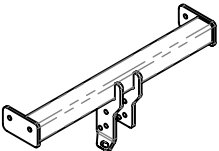
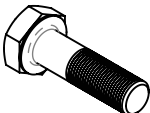
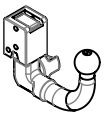
DE Der Freiraum nach Anhang VII, Abbildung 25a/b der Vorschriften 55.01 EG ist zu gew 25a/b abzugeben bei zulässigem Gesamtgewicht des Fahrzeuges.

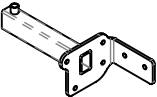
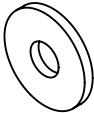
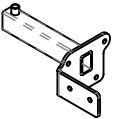
Moment skręcący dla śrub i nakrętek (8.8) Torgue settings for nuts and bolts (8.8)	
M8	25Nm
M10	55Nm
M12	85Nm
M14	135Nm
M16	195Nm





	A	x1		M12x130	2
				M12x40	4
				M12x22	6
	B	x1		M12	4
	C	x1		Ø36xØ13x3	4
	D	x1		13	4
	E	x2		12,2	8
	F	x2			
	G	x1			
	H	x1			

Śruba M12x130-8.8 ; Bolt
Podkł. okr. Ø36x Ø13x 3 ; Plain Washer

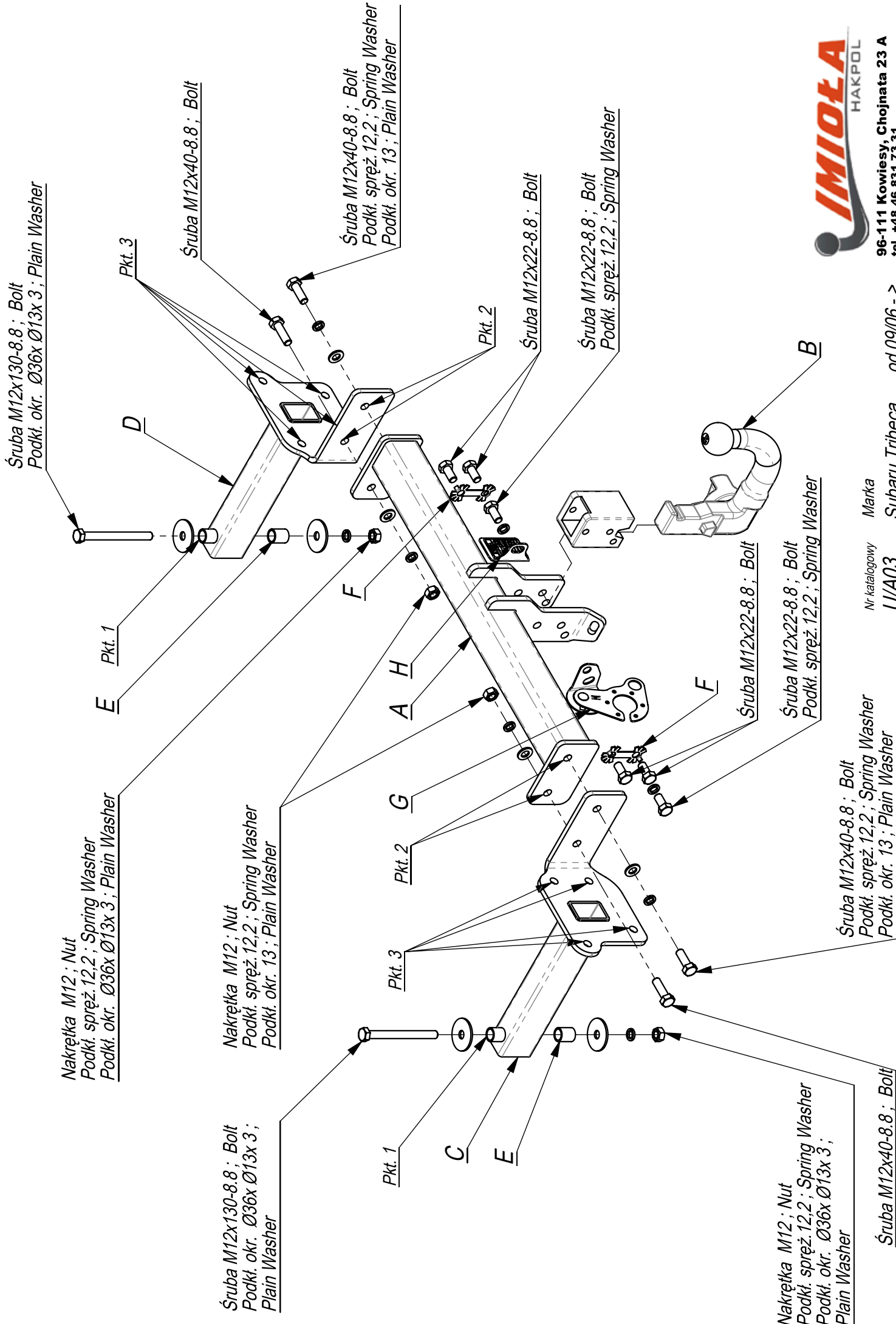

Nakrętka M12 ; Nut
Podkł. spręż. 12,2 ; Spring Washer
Podkł. okr. Ø36x Ø13x 3 ; Plain Washer

Śruba M12x130-8.8 ; Bolt
Podkł. okr. Ø36x Ø13x 3 ;
Plain Washer

Nakrętka M12 ; Nut
Podkł. spręż. 12,2 ; Spring Washer
Podkł. okr. 13 ; Plain Washer

Śruba M12x40-8.8 ; Bolt
Podkł. spręż. 12,2 ; Spring Washer
Podkł. okr. 13 ; Plain Washer

Śruba M12x22-8.8 ; Bolt

Śruba M12x22-8.8 ; Bolt
Podkł. spręż. 12,2 ; Spring Washer

Śruba M12x22-8.8 ; Bolt

Śruba M12x22-8.8 ; Bolt
Podkł. spręż. 12,2 ; Spring Washer

Śruba M12x40-8.8 ; Bolt
Podkł. spręż. 12,2 ; Spring Washer
Podkł. okr. 13 ; Plain Washer

Nakrętka M12 ; Nut
Podkł. spręż. 12,2 ; Spring Washer
Podkł. okr. Ø36x Ø13x 3 ;
Plain Washer

Śruba M12x40-8.8 ; Bolt



96-111 Kowiesy, Chojnata 23 A
tel. +48 46 831 73 31

Nr katalogowy U/A03
Marka Subaru Tribeca

od 09/06 - >

